



Instanta

# SureFlow

Counter-top series

CTS11F (1501F), CTS17F (3001F), CTS19F/6 (3001F/6) models



Instanta verified original instructions: EN version.

# Table of contents

SECTION 1 Using these instructions .....	3
Before you start .....	3
Explanation of symbols .....	3
Introduction .....	3
SECTION 2 IMPORTANT SAFETY INSTRUCTIONS.....	4
SECTION 3 WARNINGS & REGULATORY INFORMATION.....	6
SECTION 4 Technical data .....	9
4.1 Explanation of product codes for complete range .....	9
4.2 Technical data table.....	10
4.3 Construction and functionality.....	10
SECTION 5 Parts supplied .....	11
5.1 Supplied parts checklist.....	11
5.2 Filter identification and capacities .....	11
SECTION 6 Installing the appliance .....	12
6.1 Positioning and ventilation .....	12
6.2 Connect the drip tray overflow to waste .....	14
6.3 Push fit best practice.....	14
6.4 Connect the water supply.....	15
6.5 Earth continuity test .....	18
6.6 Connect the electricity supply .....	19
SECTION 7 Commissioning and operation .....	20
7.1 Switch on and commissioning .....	20
7.2 Operation .....	21
SECTION 8 Maintenance .....	22
8.1 Replace and flush the filter .....	22
8.2 Adjust the water temperature and filter monitor .....	25
8.3 Cleaning.....	26
SECTION 9 Troubleshooting .....	27
9.1 Troubleshooting table .....	27
9.2 Safety controls .....	28
9.3 In case for accidental freezing .....	29
9.4 Taps.....	29
Environmental information .....	30
Warranty.....	31

## SECTION 1 Using these instructions

### Before you start



Read and use the instructions supplied with individual kit components for a safe installation.

### Explanation of symbols



Read the instructions



WARNING



Danger of electric shock



Hot surface

## Introduction

Dear Customer,

Congratulations on the purchase of your Instanta appliance.

- Your new appliance is designed to give you years of trouble-free service provided that the instructions contained in this manual are followed.
- All new Instanta products are energy efficient, simple to operate and easy to service.
- These instructions are available on our website at [www.instanta.com](http://www.instanta.com).

## SECTION 2 IMPORTANT SAFETY INSTRUCTIONS



### **Compliance**

In the UK the system must be installed in accordance with water supply byelaws, current IEEE regulations and local authority byelaws.

### **Safety**

This appliance can be used by children from 8 years or persons (including children from 8 years) with reduced physical, sensory or mental capabilities, or lack of experience and knowledge, if they have been given supervision or instruction concerning the use of the appliance by a person responsible for their safety. Children should be supervised to ensure that they do not play with the appliance.

Cleaning and user maintenance shall not be made by children without supervision.

### **Qualifications**

To avoid hazards, all installation procedures must be carried out by a suitably qualified tradesperson. The power cable and power outlet must be in a safe visible position for connection.

### **Venting**

Sometimes steam and / or boiling water droplets may discharge through the vent / overflow outlet on the appliance. Ensure that the vent / overflow is directed to waste via a 20mm air gap.

### **Lifting**

Take care when lifting. The appliance may exceed safe lifting limits. If you feel this is beyond your personal capabilities, please seek assistance with the lift. Do not lift the appliance by the tap.

### **Airflow**

The appliance operates within the ambient temperature range 5°C - 35°C. Proper air circulation must be provided. The system will operate satisfactorily only if the recommended air gaps are provided.

### **Installation**

The appliance must be installed on a horizontal surface sufficiently robust

## SECTION 2 IMPORTANT SAFETY INSTRUCTIONS

to support its weight. Locate in an area of adequate space to use the boiler safely (e.g. free from tripping hazards and risk of congestion).

### Frost protection

This appliance is not designed for outdoor use.

Ensure that the appliance is installed in an area where the ambient air temperature cannot fall below 5°C.

If the ambient air temperature should fall below 5°C when the system is not in use, do not turn off the appliance electrically to prevent it from freezing. This safeguard does not offer the same protection to the connecting pipework and fittings.

### Servicing

Service procedures must be carried out by a suitably qualified and trained tradesperson.

Access to the interior of the appliance to perform service operations is restricted. A screwdriver is required to remove the access covers.

The appliance must be disconnected from its power source during service and when replacing parts.

During service the person servicing the appliance must be able to check from any of the points around the appliance to which he has access, that the appliance is disconnected from its power source.

### Application

The appliance is intended to be installed in a commercial environment, where it is supervised by a trained operator, who can also train staff in it's safe use.

## SECTION 3 WARNINGS & REGULATORY INFORMATION



- FOR CONTINUED SAFETY OF THIS APPLIANCE IT MUST BE INSTALLED, OPERATED AND MAINTAINED IN ACCORDANCE WITH THE MANUFACTURER'S INSTRUCTIONS.
-  The appliance must be earthed, earthing is provided via the power cable. The resistance of the earth connection to each exposed metal part must be less than  $1\Omega$ . It is the responsibility of the installer to ensure the power point is earthed.
- All installation and service work must be completed by trained and suitably qualified tradespeople. Faulty operation due to unqualified persons working on this product may void warranty coverage.
- Electrical installation must conform to current IEEE wiring regulations.
- When using fixed wiring, the bare section of earth must be sleeved to within 8mm of the end.
- As the installer, it is your responsibility to install the appliance safely to local regulations and relevant standards and to supply and install all valves as required by local regulations and relevant standards.
- 6kW rated appliances must be connected to the mains supply via an all-pole disconnection isolator switch.
- The appliance is rated for 220-240V 50Hz AC operation.
- In order to avoid a hazard due to inadvertent resetting of the thermal cut-out, this appliance must not be supplied through an external switching device such as a timer, or connected to a mains supply that is regularly switched on and off.
- For service work, do not remove the cover of the appliance under any circumstances without first isolating it from the power supply.
- The appliance is IP20 rated, it is not suitable for installation in an area where a water jet could be used. Do not expose the appliance to the elements of nature.
- A pressure limiting valve must be fitted for mains water pressures above the max. limits stated.
- Use of tools can be hazardous, assess the risks before you start.

## SECTION 3 WARNINGS & REGULATORY INFORMATION

- A clearance envelope around the appliance must be provided to allow adequate ventilation and service access for safe and effective use.
- Valve and fitting threads must be sealed appropriately with PTFE tape where compression seals are not provided. Do not over tighten plumbing and hose connections.
- The power cord and power outlet must be in a safe and accessible position after installation. When positioning the appliance, ensure the power supply cord is not trapped or damaged. If it is damaged it must be replaced by an Instanta service provider or a qualified electrician in order to avoid a hazard.
- For safe operation, the appliance is designed to be installed, commissioned and used within 48 hours. Should it not be required for an extended period of time , do not fill and commission until ready for first use.
- For water taste and quality reasons, following any non-use period of more than 72 hours, Instanta recommends to perform a system flush. Failure to flush the system may affect water quality.
- For UK, this appliance only contains materials that conform to the requirements of BS6920:2014 'Suitability of non metallic materials and products for use in contact with water intended for human consumption with regard to their effect on the quality of water'.
- Instanta cannot be held responsible for any appliance malfunction if the water pressure exceeds that stated. If in doubt, consult your water supply company.
- Instanta cannot be held responsible for lime-scale related problems even when a lime-scale reducer has been installed.
- Whilst reasonable precaution is taken to prevent an overflow, Instanta cannot be held responsible for any damage caused as a result of incorrect installation or blockage of the overflow or failure to direct the overflow to a safe outlet.
- To meet WRAS installation requirements, an approved single-check valve providing back-flow prevention protection, should be fitted at the point of connection between the water supply and the appliance.

## SECTION 3 WARNINGS & REGULATORY INFORMATION

- Water that has been treated by the reverse osmosis process can become aggressive (due to lack of minerals or ions), and in extreme cases can cause leaching and corrosion of pipes, fittings and other metal parts within the appliance.
- If the appliance is being fed by water treated by reverse osmosis, Instanta strongly recommend that the water is tested regularly.
- If the appliance is being fed by water treated by reverse osmosis, Instanta strongly recommend that the water is tested regularly.
- If micro-bore pipe is used instead of the inlet hose supplied, the size must be minimum OD 3/8" (10mm).
- The new detachable hose set supplied with the appliance must be used. Do not re-use old hose sets.
- Place the appliance in an environment suitable for its size and use, making sure that it is placed in a horizontal position, make sure that the appliance does not have an inclination greater than 2°.
- The appliance does not use materials containing flammable blowing gases.
- The appliance does not contain asbestos or oils containing polychlorinated biphenyl.



## SECTION 4 Technical data

### 4.1 Explanation of product codes for complete range

#### Complete Counter Top range appliance order code

Product group	Product range		Draw off (l)		Features		kW rating		
CT	CounterTop	S	SureFlow	3	3	V	High volume	-	3
		SP	SureFlow Plus	5	5	BC	Boiling chilled	/6	6
				10	10	F	Filtered	/9	9
				11	11	H	High tap	/18	18
				13	13	T	Twin tap		
				15	15	SL	Slim line		
				17	17	PB	Push button		
				19	19	TF	Touch free		
				27	27				
				35	35				
				45	45				
				50	50				
				135	135				

#### Example highlighted above

CT — S — 11 — F

CTS11F - CounterTop SureFlow range, 11 litre with filter, 3kW rating.

**Model number - Appliance order code cross reference** (for list of appliances described in this manual).

Model number	Order code
1501F	CTS11F
3001F	CTS17F
3001F/6	CTS19F/6

## SECTION 4 Technical data

### 4.2 Technical data table

Model	Unit	CTS11F (1501F)	CTS17F (3001F)	CTS19F/6 (3001F/6)
Width	mm	243	243	243
Depth*	mm	362	362	362
Depth inc. drip tray	mm	510	510	510
Height	mm	610	668	668
Supply voltage	V	230V 50Hz AC		
Power rating	kW	3	3	6
Power supply required		Single phase		
Fill type		Automatic		
Capacity	L	11	17	19
Rapid draw off	L	10	17	19
Weight (empty)	kg	13.2	14.4	14.8
Weight (full)	kg	26	32.7	33.1
Water inlet connection		3/4" BSP		
Ambient temp. range		5 - 35		
IP rating		IP20		
Water supply pressure range	bar MPa	2.0 - 7.0 0.2 - 0.7		
A weighted emission sound pressure	dB(A)	Less than 70		

**Note** \*Depth measurement excludes tap protrusion (+85mm).



**A pressure limiting valve must be fitted for mains water pressures above the max. limits stated above in accordance with local plumbing regulations.**

### 4.3 Construction and functionality

- Outer casing and tank are constructed in type-304 and type-316 grade stainless steel. The tank is fully insulated with high-temperature polystyrene.
- The appliance has electronic control of the main functions. This means that the heating, filling and temperature are controlled precisely within given parameters.

**Note** Mains water isolation valve is not supplied with the kit. Contact us on 0345 6 005 005 for the full range of consumables and accessories.

## SECTION 5 Parts supplied

### 5.1 Supplied parts checklist

- Before starting installation check that you have the following parts.

Qty	Description
1	Appliance & Tap kit
1	Drip tray, overflow spigot, nut & washer
1	¾" BSP water inlet hose
1	Installation and user instructions
1	AQ35 filter

### 5.2 Filter identification and capacities

#### Identification

- For lime-scale prevention, the appliance is supplied with an AQ35 lime-scale filter.
  - The filter is identified on its front label.

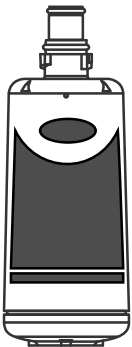

AQ35

#### AQ35 lime-scale filter capacities

- Soft water areas 13000 litres.
- Medium water areas 9000 litres.
- Hard water areas 6000 litres.

## SECTION 6 Installing the appliance

### 6.1 Positioning and ventilation



Use of tools can be hazardous, assess the risks before you start.



Use instructions supplied with individual kit parts.

- Install the appliance within reach of a mains wholesome (cat 1) water supply, and a 230V 50Hz mains electricity supply.
- Use the illustration below as a guide, and follow the steps through this section of the manual.

#### 6.1.1 Clearance envelope



A clearance envelope must be provided.

- A clearance envelope must be provided to allow service access and ventilation for the safe and effective use of the appliance.

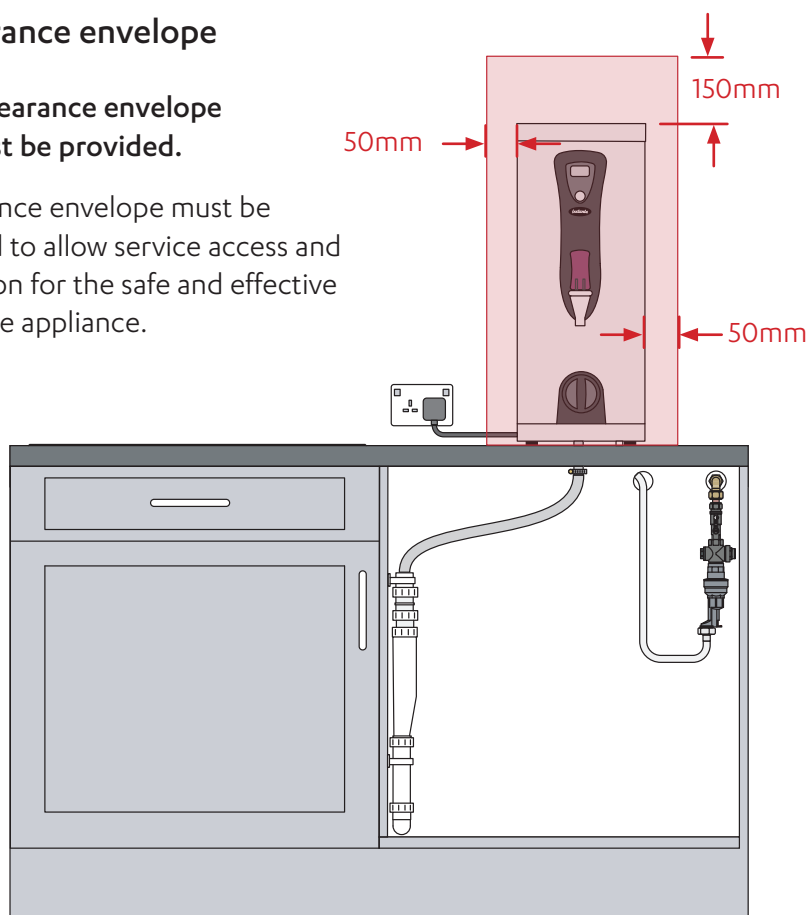

## SECTION 6 Installing the appliance

### 6.1.2 Installation layout and features (inc optional Water block and install rail)

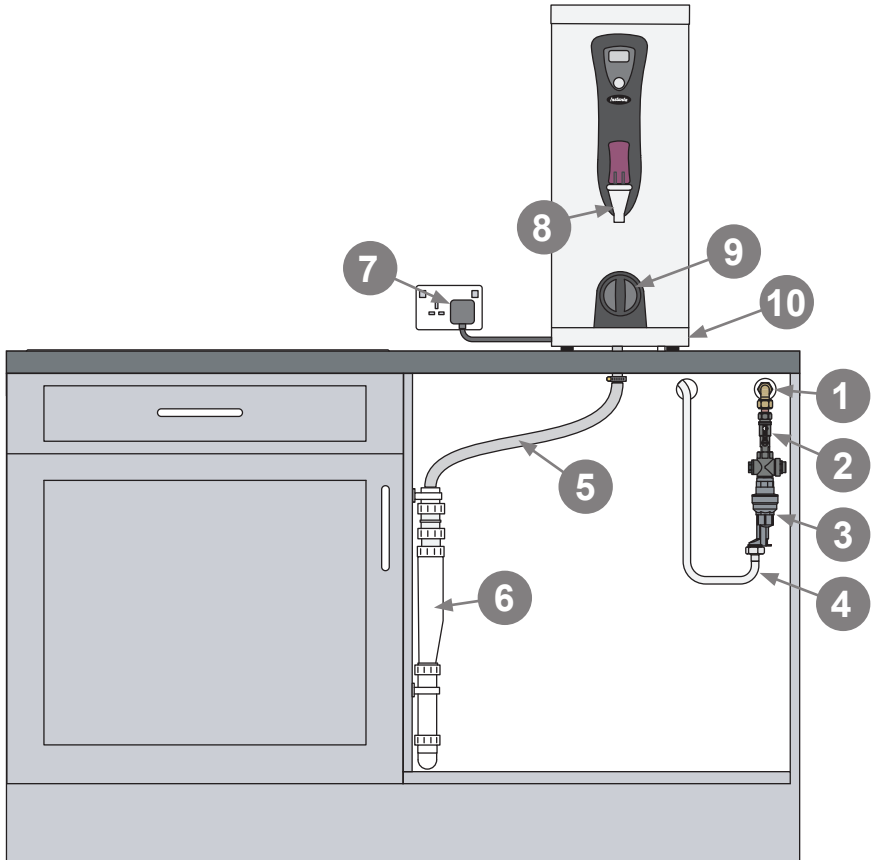

- |   |                                |    |                           |
|---|--------------------------------|----|---------------------------|
| 1 | Mains water supply             | 6  | Waste to drain            |
| 2 | Isolation valve & install rail | 7  | Mains electricity supply  |
| 3 | Water block (optional)         | 8  | Dispensing tap            |
| 4 | 3/4" BSP mains water hose      | 9  | Water filter cap & handle |
| 5 | Drip tray flexible drain hose  | 10 | Drip tray                 |

## SECTION 6 Installing the appliance

### 6.2 Connect the drip tray overflow to waste

An air gap must be provided within 300mm of the overflow connection point.



Failure to provide an air gap within this distance could cause an air lock which could stop the water discharging in the event of an overflow.

**IMPORTANT** Overflow pipework must be no less than 15mm diameter.

- Remove the bung from the overflow pipe on the front left of the appliance.
- Remove the bung on the drip tray base.
- Determine the drip tray position. Ensure that the appliance front overflow brass connection is directed into the drip tray overflow slot.
- Lift off the drip tray grille.
- Connect the drip tray to waste, via the spigot provided, 15mm compression fittings and min. 15mm dia. pipework.
- Replace the drip tray grille.
- Place the drip tray in position.

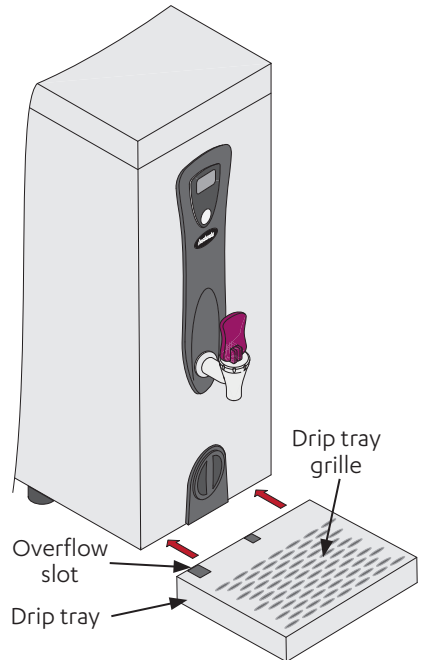

### 6.3 Push fit best practice

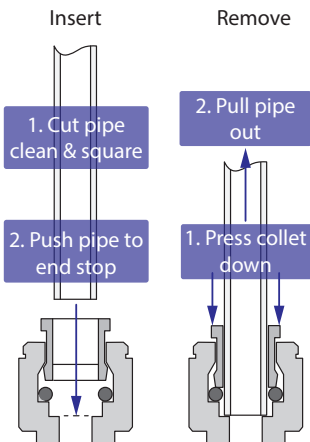

## SECTION 6 Installing the appliance

### 6.4 Connect the water supply



Valves and fittings must be sealed with PTFE tape if compression seals are not included.

Water supply pressure range 0.2 - 0.7MPa.



If the mains water pressure is below 0.2 MPa a fault could arise. If the mains water pressure exceeds 0.7 MPa bar a suitable water pressure reducing valve must be fitted. Failure to do so could result in the appliance overflowing.



To avoid damage, do not use any solder connections whilst pipes are connected to the appliance.

Instanta cannot be held responsible for any appliance malfunction if the water pressure is not within the range stated. If in doubt, consult your water supply company.



Use instructions supplied with the individual system components

#### 6.4.1 Mains water connection (standard arrangement)

- Connect to a wholesome (cat 1) cold drinking water supply using 15mm copper pipe-work.
- A 15mm isolation valve must be fitted between the water supply and the appliance so that it can be isolated for service and repair.

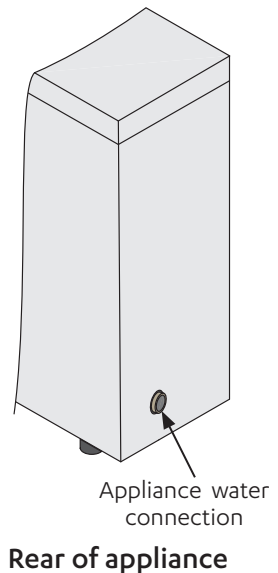
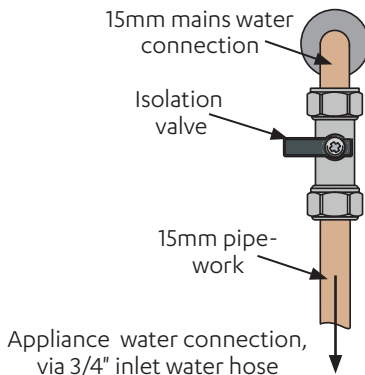

## SECTION 6 Installing the appliance

### 6.4.2 Mains water connection (optional arrangement) (Install rail & Water block arrangement)



**Use instructions supplied with the individual system components.**

- Fitting a Water block (available from Instanta) will limit the amount of water flowing to a predetermined flow rate, lowering the risk of harm to people and damage to property.
- Use the arrangement shown in the adjacent diagram for water supply including a Water block system.
- See next page for Water block installation requirements.

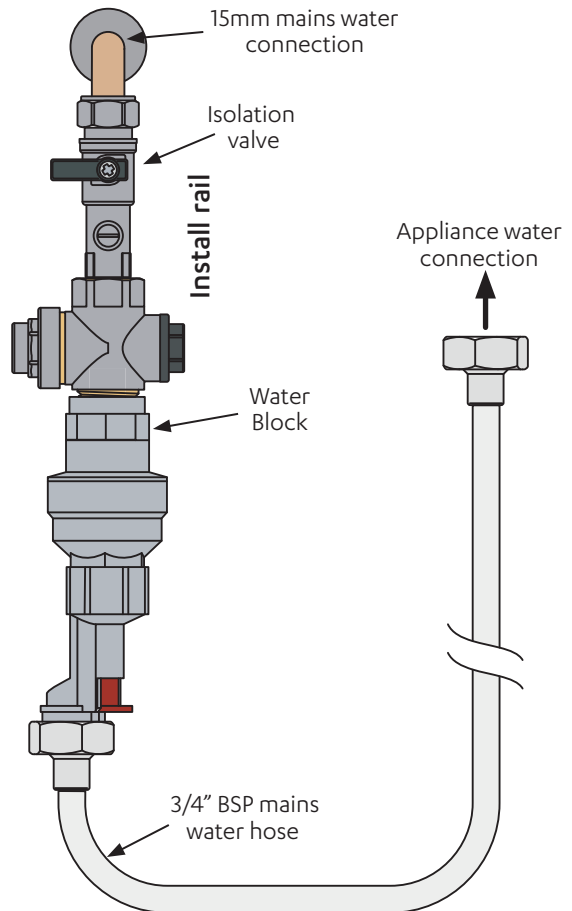
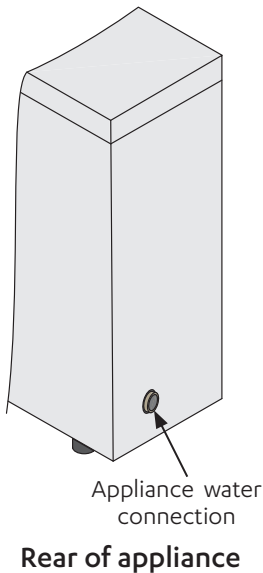



## SECTION 6 Installing the appliance

### 6.4.3 Water block (optional)



This device must be installed vertically with the direction of flow downwards (inlet at the top, outlet at the bottom). See Fig. 1.

- The Water block should be installed in a convenient location on the water supply line to the appliance.
- Rotate Pointer 'P' (see Fig.3) until in line with the max. required flow. The number scale corresponds to 5 litres of flow i.e. 1 = 5 litres, 10 = 50 litres.
- The key (see Fig.2) should be used to adjust the pointer.
- The inlet should be connected via a 15mm copper tail or install rail.
- The outlet shall be connected via the 3/4" - 3/8" push fit brass fitting supplied.
- Ensure that the direction of flow through the Water block is correct and that the filter screen (see Fig.2) is inserted correctly with the convex surface facing towards the water supply.

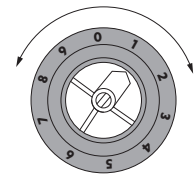
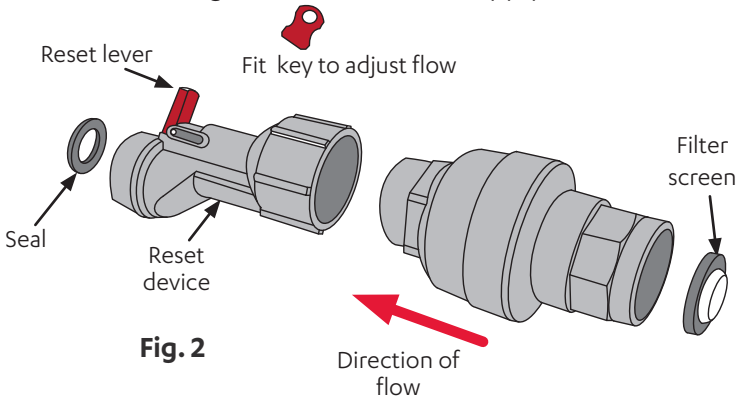
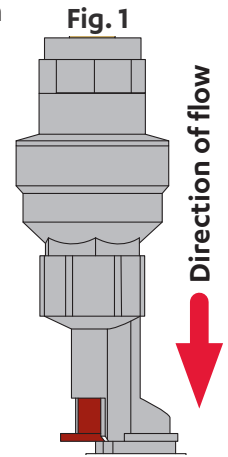

### 6.4.4 Reset Procedure

- The Water block will activate and shut off the supply if more water than the set amount is drawn off at one time.
- In this event isolate the water supply to the Water block.
- Identify and repair the leak then press the reset lever (Fig. 2).
- Tripping issues, contact Technical support on 0345 6 005 005 for advice.

## SECTION 6 Installing the appliance

### 6.5 Earth continuity test



All accessible metal parts must be earthed.

- After installation, the earth continuity must be checked. Use an insulation tester, appliance tester, DMM or continuity tester with an accuracy of Class 5 or better ( $\pm 5\%$  at full-scale deflection).

#### 6.5.1 To test the earth continuity

- Isolate the appliance from the electricity supply.
- Set the meter to the lowest ohms ( $\Omega$ ) scale and set to a reading of  $0\Omega$  with the meter probes connected together.
- Connect one of the meter probes to the earth wire of the mains cable.
- Connect the second meter probe to a bare patch of metal or a screw (the edge is best) on the appliance and read the display.
- Repeat with the second test probe touching the metal body of the tap.
- All readings should be less than  $1\Omega$ .
- If any of the readings are above this value, check the earth connection inside the appliance.

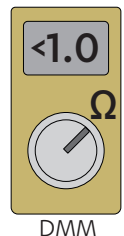
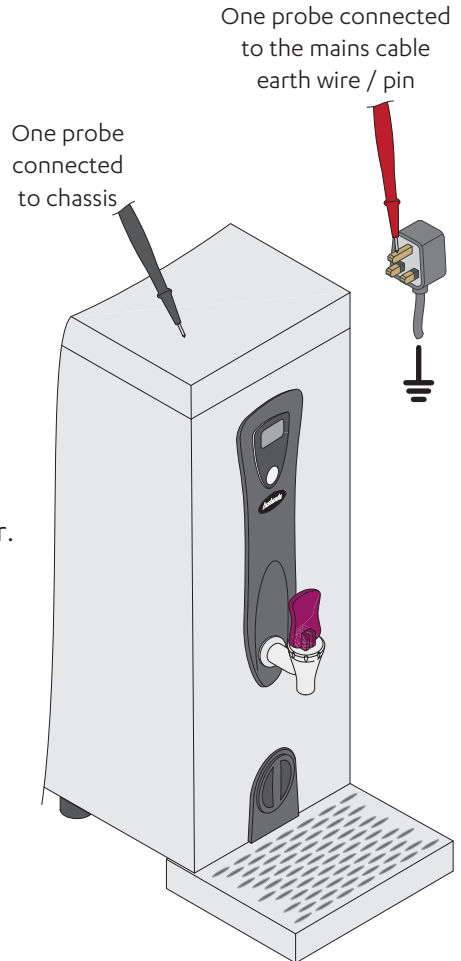

## SECTION 6 Installing the appliance

### 6.6 Connect the electricity supply



Before you start, read :  
Section 2 Important safety instructions.  
Section 3 Warnings & Regulatory information.

Do not switch on the mains electricity supply until installation is complete,  
The system earth must be verified once the mains electricity supply connection has been established.

#### CTS11F (1501F), CTS17F (3011F)

- Connect the appliance 13A bonded 3 pin plug to an earthed mains 13A 230V 50Hz supply socket.

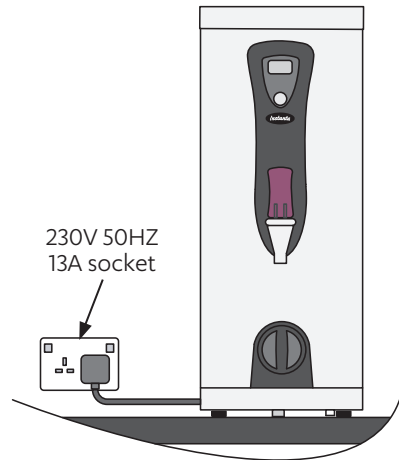

#### CTS19/6, (3001F/6)



Installation must be completed  
by a trained and suitably  
qualified tradesperson

- The appliance is supplied with a 1.5m long 3-core, 4.0mm<sup>2</sup> cable.
- Connect the 3-core mains cable to a 30A 230V 50Hz supply via an all-pole disconnection isolator switch.
- The isolation switch must be easily accessible.

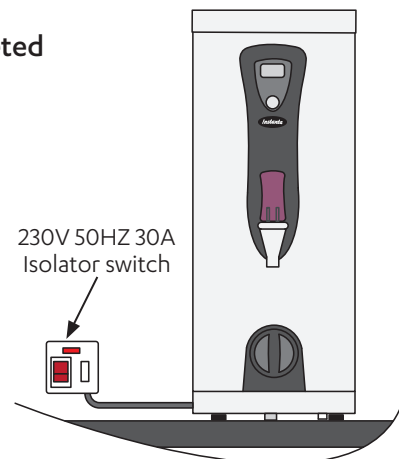

### 7.1 Switch on and commissioning



Use with caution, the appliance dispenses near-boiling water.

- Turn on the water supply.
- Switch on the mains power supply.
- The red illuminated screen reads NOT READY, FILLING.
- The appliance begins to fill with water.
- Once primed with water, the appliance begins to heat.
- The red illuminated screen reads NOT READY, HEATING to show that the water is being heated to the correct temperature.
- When the correct temperature has been reached, the display illumination changes from red to white and the HEATING symbol extinguishes.
- When the screen reads READY, drain off 10 litres of water from the tap to flush the filter.
- The appliance continues the heat/fill cycle until the tank is at full capacity (during the heat/fill cycle, small amounts of water are added to ensure the water at the tap is always at the correct temperature).
- Following filter flush, (when the screen reads READY again), the appliance is ready to use.



In normal daily use, the appliance may be used as soon as READY is displayed, but on first install, wait 15 minutes before starting to use.

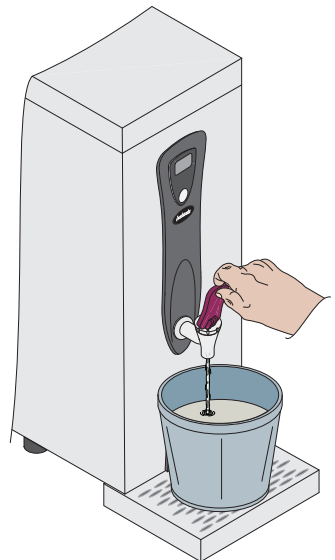

## SECTION 7 Commissioning and operation

### 7.2 Operation



Use with caution, the appliance dispenses near-boiling water.

- Switch on the appliance and wait until the white illuminated screen reads READY.
- The water will be at the correct temperature.
- Dispense water using the lever tap on the front of the appliance.

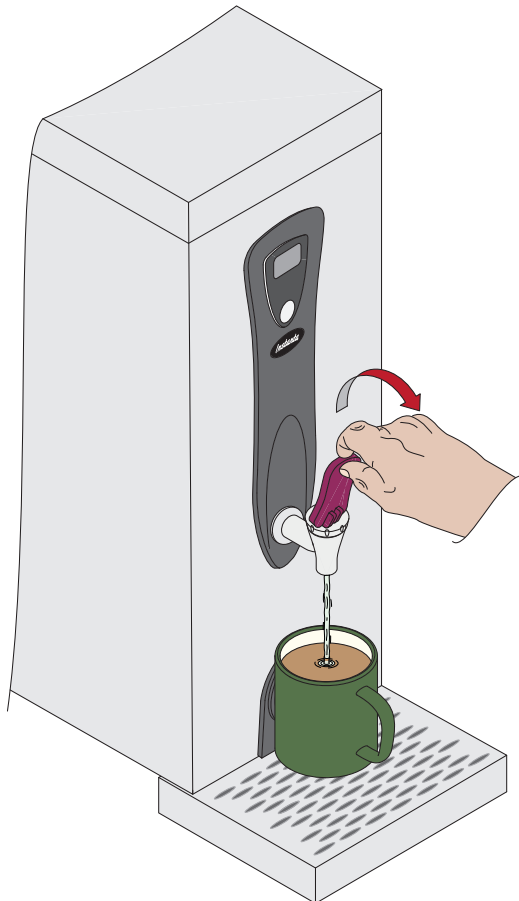

### 8.1 Replace and flush the filter

- The filter symbol displays a line of bars to show the remaining life of filter cartridge.
- When the filter has 200 litres remaining, the filter icon begins to flash.
- The screen reads CHANGE FILTER.
- The appliance continues to operate with the CHANGE FILTER message displayed, but lime-scale builds up more rapidly and the water taste is affected.



#### To replace the filter

- Switch off the mains electricity supply to the appliance.
- Dispense water until it stops flowing.
- Turn filter cap handle 1/4 turn anti clockwise to release.
- Pull out filter.
- Water will drain out of the filter, as it is removed.

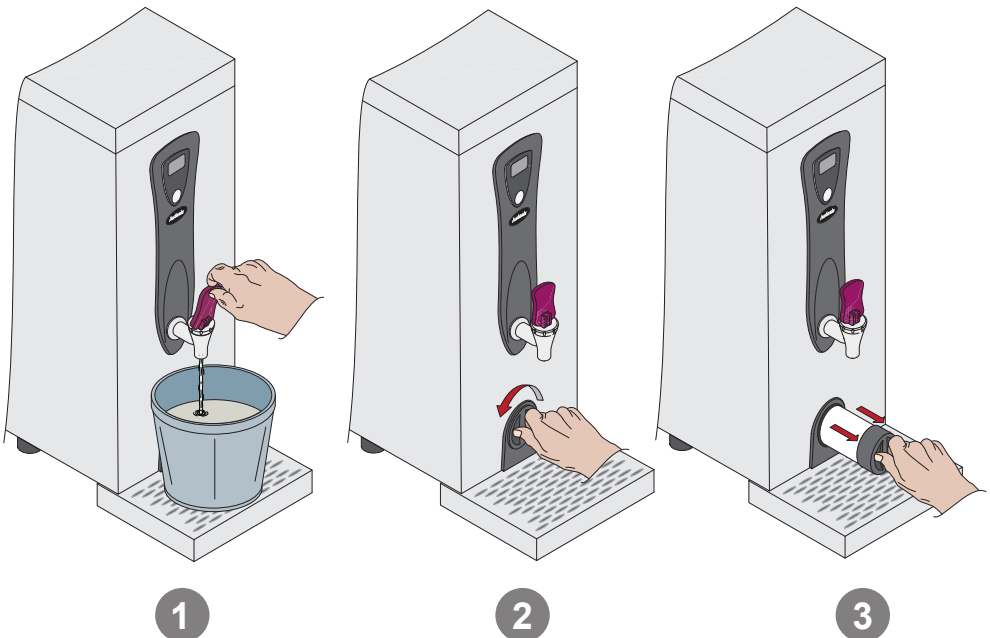

## SECTION 8 Maintenance

- Carefully un-clip one tab of the filter cap with flat blade screwdriver.
- Pull off the filter cap.
- Align the filter cap with the base of the replacement filter.

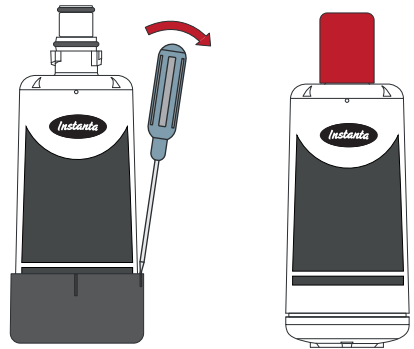

1

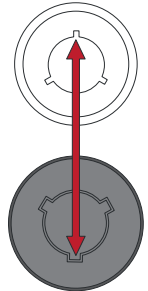

2

- Push filter base cap onto the replacement filter.
- Remove the red protective cap from the top of the filter, check that the black o-rings on the filter connector remain in position.



3

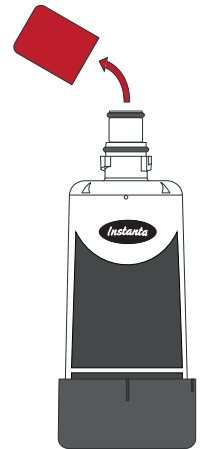

4

## SECTION 8 Maintenance

- Insert the new filter into the filter aperture.
- Turn filter cap handle 1/4 turn clockwise until it stops.
- Water supply to the tank turns on automatically.
- Switch on the mains electricity supply to the appliance.
- Press the ON button.
- Wait 15 mins. for the tank to fill.
- Drain off 10 litres of water from the tap to flush the filter.
- To reset the filter monitor, press & hold the power button for 6 seconds.
- Release the power button.
- The screen illuminates.
- Filter symbol is full.

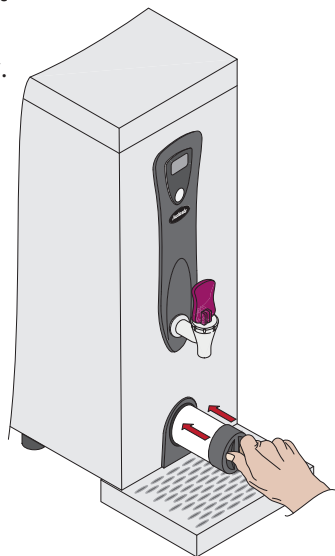

1

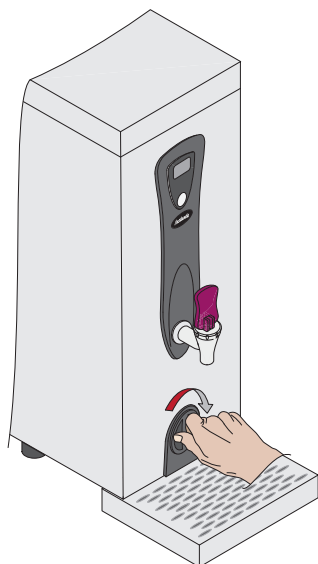

2

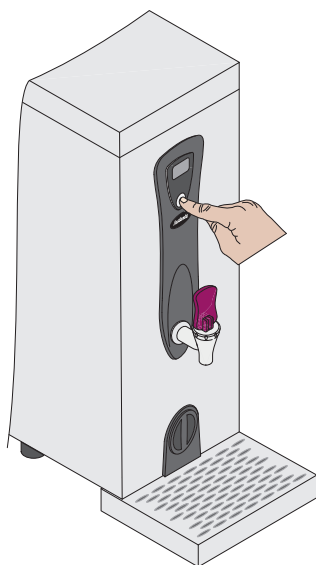

3

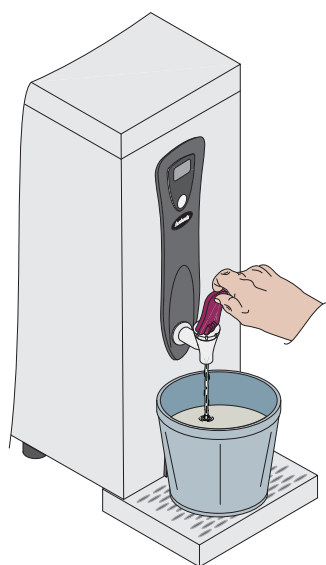

4



## SECTION 8 Maintenance

### 8.2 Adjust the water temperature and filter monitor

- The filter monitor is factory-set to MEDIUM (default) which is suitable for most of the UK with average or medium water hardness.
- The effectiveness of the filter will be reduced in hard water areas and extended in soft water areas.
- For water hardness information, consult your local water authority or call us on 0345 6 005 005.
- The filter monitor setting can be changed from MEDIUM to HARD or SOFT as follows.
- Press & hold on/off button for 12 secs.
- Red illuminated screen reads PR in top corner.
- Release on/off button.
- Temperature setting is displayed.
- Press the power button to toggle through to the desired temperature.
- Press & hold on/off button (long push) for 5 seconds until screen reads MEDIUM (default).
- Press button (short push) to scroll between the different filter settings; SOFT, MEDIUM, HARD, EMPTY FILTER SYMBOL (No filter monitor).
- With the required filter setting selected, Press & hold button (long push) for 4 seconds to save.
- Press & hold on/off button (long push) for approximately 6 seconds until display goes blank.
- Press & hold on/off button to turn appliance back on again.
- TO RE-SET & CONFIRM NEW SETTINGS;...Press & hold button, screen will go blank but continue to hold, until red illuminated screen reads READY.

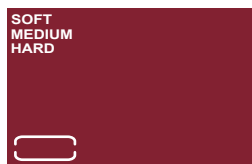
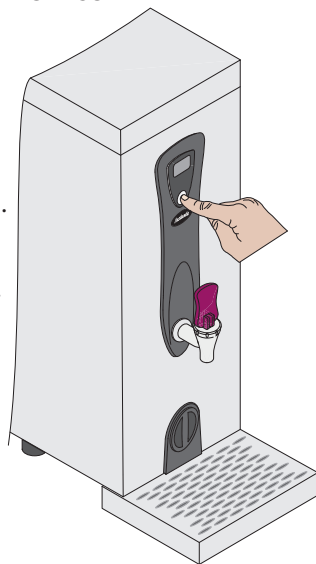

### 8.3 Cleaning



**Do not use air-drying disinfectant sprays.**







**Do not use abrasive cleaning agents to clean the appliance.**

**The appliance must never be located near or cleaned with water jets.**

- To clean the appliance and tap, wipe surfaces with a damp cloth and then wipe dry with a clean, dry cloth.
- Do not use disinfectant sprays without wiping dry afterwards.
- This could cause permanent malfunction and void warranty.

## SECTION 9 Troubleshooting

### 9.1 Troubleshooting table

Non functional warnings	Possible causes	Action	
 <p><b>READY</b> CHANGE FILTER</p>	Filter cartridge is exhausted	Replace filter - type AQ35  Call us on 0345 6 005 005 for a new filter to discuss on-site support and HydroCare plans.	
 <p><b>READY</b> ! CHECK WATER !</p>	Water turned off. Inlet hose kinked or bent. Low in-coming water pressure.	Check water supply and stop-cock.  Check in-coming water is at minimum of 2-bar.	
 <p><b>READY</b> ! CLEAN PROBES !</p>	Low-water level probe scaled up.	De-scale required. Call us on 0345 6 005 005 for on-site support and HydroCare plans.	
FLASHING	 <p><b>NOT READY</b> HEATING</p>	Over boil safety cut-out tripped on initial heat up.  Faulty element.  Boil dry safety switch tripped.	Turn off appliance, wait 10 mins, turn back on.  If fault persists, call us on 0345 6 005 005 for on-site support and HydroCare plans.
FLASHING	 <p><b>NOT READY</b> HEATING</p>	Over boiled when in 'READY' mode due to excessive lime-scale in tank. Temperature sensor disconnected or wires cut.	De-scale required. Reduce temperature settings.  If fault persists, call us on 0345 6 005 005 for on-site support and HydroCare plans.
FLASHING	 <p><b>NOT READY</b> OF</p>	Appliance has over filled to top level sensor	De-scale required. Reduce temperature setting.  Call us on 0345 6 005 005 for on-site support and HydroCare plans.
FLASHING	 <p><b>NOT READY</b> TH</p>	Thermistor failed	Call us on 0345 6 005 005 for on-site support and HydroCare plans.

### 9.2 Safety controls



Isolate appliance from power supply before removing the access cover or attempting any reset.

In order to avoid a hazard due to inadvertent resetting of the thermal cut-out, this appliance must not be supplied through an external switching device such as a timer, or connected to a mains supply that is regularly switched on and off.

In certain circumstances, one of two different safety controls within the appliance may have activated.

#### **Over-boil safety cut-out**

Activates if the appliance produces excess steam. This can be due to :

- Lime-scale within the tank.
- A temporary interruption in the water supply.
- A faulty temperature sensor or internal component (triac).

#### **To reset the over-boil safety cut-out**

- Switch off at the mains power supply and allow the appliance to cool down for ten minutes before switching back on (the safety device should automatically reset).

#### **Boil-dry safety cut-out**

- Activates if the appliance has been boiled dry, for example, due to lime-scale build-up or water starvation.

#### **To reset the boil-dry safety cut-out**

- If the boil-dry cut-out has activated, this will require a manual reset.
- Call us on 0345 6 005 005 to book a service call.

### 9.3 In case for accidental freezing



Before you start read :

**Section 2 Important safety instructions.**

**Section 3 Warnings & Regulatory information.**

- Ensure that ambient environmental conditions around the appliance are above the minimum operating temperature of the appliance.
- Turn off the electricity and water supplies for 12 hours to allow the appliance to defrost, then turn back on.

### 9.4 Taps

- Taps are subject to wear & tear but in the event of a tap failing within 12 months of installation, we will be pleased to replace the tap assembly by post. Fitting is very simple and requires no tools. An engineer call out is not necessary.
- For accidental damage, misuse or use not in accordance with these instructions and damage caused by incorrect installation. The manufacturer disclaims any liability for incidental, or consequential damages.

### Waste electrical and electronic equipment

- The symbol above means that according to United Kingdom and European Union member countries laws and regulations, your product and/ or its battery shall be disposed of separately from household waste.
- When this product reaches its end of life, take it to a collection point designated by local authorities. The separate collection and recycling of your product and/ or its battery at the time of disposal will help conserve natural resources and ensure that it is recycled in a manner that protects human health and the environment.

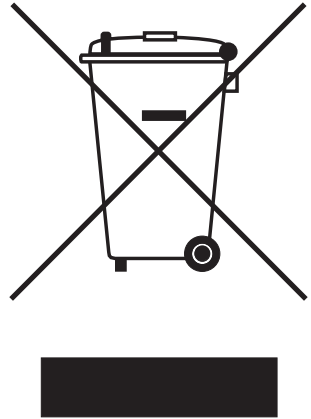

### Warranty

- The appliance is guaranteed for two years from date of installation.
- Our guarantee includes on site labour and parts for problems caused by fault of manufacture and component failure with the following exclusions:
- Problems caused by hard water and lime-scale. We regret that we cannot be held responsible for problems caused by hard water.
- Accidental damage, misuse or use not in accordance with these instructions and damage caused by incorrect installation.
- The manufacturer disclaims any liability for incidental, or consequential damages.



**Zip Water UK  
Instanta**

Trafalgar House,  
Rash's Green, Dereham,  
Norfolk, NR19 1JG  
0345 6 005 005

[www.zipwater.co.uk](http://www.zipwater.co.uk)  
[www.instanta.com](http://www.instanta.com)

